

## ACE M1 Mobile Label Printer

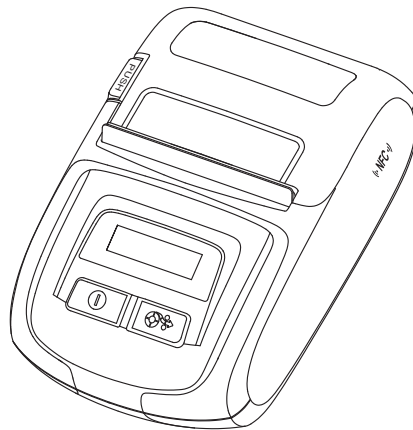

Please read this Manual carefully before using the printer and keep it for future reference

# Contents

---

---

Preface.....	1	V. Setting.....	13
About This Manual.....	1	5.1 Enter Setting Screen .....	13
Icons and Practices.....	1	5.2 Self-test .....	14
Related Manual Information.....	1	VI. Icon description.....	15
Safety Instruction.....	2	VII. Communication.....	16
I. Standard Configuration.....	5	7.1 USB Communication .....	16
II. Appearance and Components.....	6	7.2 WiFi Communication .....	17
III. Preparation Before Use.....	8	7.3 Bluetooth Communication .....	17
3.1 Battery Installation .....	8	VIII. Repair and Maintenance.....	18
3.2 Battery Charging .....	9	8.1 Daily Maintenance of Printer.....	18
3.3 Installation Method 1 of Printing Paper Roll....	10	8.2 Use and Storage of Printing Paper.....	18
3.4 Installation Method 2 of Printing Paper Roll....	11	IX. Troubleshooting. ....	19
IV. Basic Functions.....	12	X. Appendix.....	20
4.1 Power On .....	12	10.1 Printer Parameters .....	20
4.2 Power Off .....	12	10.2 Battery Recycling.....	21
4.3 FEED.....	12		
4.4 Auto Learning of Paper Types.....	12		
4.5 Auto Sleep/Wake.....	12		

# Preface

---

---

## About This Manual

Thank you for purchasing the mobile label printer produced by Rongta.

This manual can help you easily learn to use this product. Please read this manual carefully before using the printer and keep it properly so that everyone who uses this product can read it.

## Icons and Practices

For your convenience, this Manual uses the following symbols (icons) and practices:

 **WARNING** warns that improper use may result in property damage, serious injury or death.

 **ATTENTION** indicates that improper use may result in personal injury or property damage.

 **NOTE** indicates that the information listed allows you to use the product better or extend the service life of the product.

## Related Manual Information

Various manuals provide detailed instructions for various technical problems.









 The illustrations and text used in this Manual may differ from the actual product.





# Safety Instruction

---





---







Please follow the following precautions when using the printer:

-  **ATTENTION** Do not disassemble the printer by yourself. Please read this manual carefully before use.
-  **WARNING** Please turn off the power immediately in case of failure. When you notice smoke or odor coming from the printer or power adapter, please unplug the power adapter and remove the battery immediately. Please be careful not to get burnt.
-  **WARNING** Please do not use the printer near gas stations, fuel warehouses and other flammable materials.
-  **WARNING** During charging, the printer and power adapter must be placed in a ventilated place with the ambient temperature of 0°C - 45°C, and be sure to use the power adapter provided by the company. The use of unapproved power adapters may be hazardous and also violates our warranty policy.
-  **ATTENTION** When the printer is printing, please do not open the cover of the paper bin; otherwise, unpredictable conditions may occur and the printer may even be damaged.
-  **ATTENTION** After printing, the print head is still at a high temperature. Do not touch it to avoid burns.
-  **ATTENTION** Please do not use dissolved matter (such as benzene thinner) to wipe the printer shell, and please keep the printer away from corrosive chemicals. You can only gently wipe the printer with a clean soft cloth.
-  **ATTENTION** Please use our original or approved printing paper; otherwise, it may lead to poor printing quality or even damage to the printer mechanism.







-  **ATTENTION** If the printer is to be stored for a long time, be sure to remove the battery from the printer and store it separately; otherwise, the battery may fail or even have leakage, which may damage the printer.
-  **ATTENTION** Make sure the printer is turned off before replacing the battery. If a power adapter is used, make sure the power is cut off before replacing the battery.
-  **ATTENTION** The printer can work stably at an ambient temperature of 0°C - 40°C. Too high or too low ambient temperature will lead to low printing quality.
-  **ATTENTION** The time that the printed text can be kept on the thermal printing paper is related to the paper quality. To print documents that need to be kept for a long time, please use long-lasting thermal printing paper.

**Please follow the following precautions when using the battery:**

-  **ATTENTION** Please carefully read this manual and symbols on the battery surface before use.
-  **WARNING** Please charge the battery in a cool and ventilated room. The high ambient temperature during charging will cause the battery to heat up, emit smoke, burn, deform, or even explode.
-  **WARNING** There are special protective circuits and devices inside the battery. Please do not disassemble the battery by yourself, or it will cause a short circuit or electrolyte leakage.
-  **WARNING** There is a risk of blindness if the electrolyte gets into the eye. In case of eye contact, rinse immediately with water and seek doctor's advice immediately.





-  **WARNING** Do not squeeze, mechanically vibrate or shake the battery, and short circuit of the battery is strictly forbidden.
-  **WARNING** Please do not put the battery into water; otherwise, it may result in internal short circuit, which may cause the battery to heat up, emit smoke, deform, damage or even explode.
-  **ATTENTION** Do not expose the battery to direct sunlight or put it in a place with excessive smoke and dust. Do not use the battery in a high humidity environment, such as a bathroom.
-  **ATTENTION** Please replace the battery if it cannot meet the performance requirements.
-  **ATTENTION** Keep the battery out of reach of children to prevent danger.
-  **ATTENTION** If you notice any discoloration or deformation of the battery, stop using it immediately.

**Please carefully read this manual and symbols on the surface of power adapter before use.**

-  **ATTENTION** Do not disassemble or modify the power adapter. Do not use the power adapter if the power line is damaged; otherwise, it may cause electric shock, fire and damage to the power adapter.
-  **WARNING** Do not touch the power adapter with wet hands. If the power adapter comes into contact with water or other liquids, cut off the power supply immediately.
-  **WARNING** Please avoid short circuit, vibration or shaking of the power adapter.
-  **WARNING** Do not use the power adapter in a high humidity environment, such as a bathroom. The equipment is not waterproof and must not be exposed to rain or moisture.
-  **WARNING** Hold the power adapter body when unplugging. Simply pulling the power line will damage the wires.
-  **ATTENTION** Keep the power adapter out of reach of children to prevent danger.

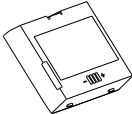
## I. Standard Configuration

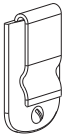
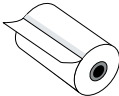

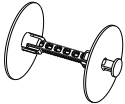
Printer (1 set)	Battery (1 pcs)	USB cable (1 pcs)	Power adaptor (1 pcs)
			
Belt buckle	Label paper (1 roll)	Quick Installation Guide	Paper width adjusting unit
			

☺ The pictures are for reference only. If any item is damaged or missing, please contact the supplier.

## II. Appearance and Components



### □ Front View

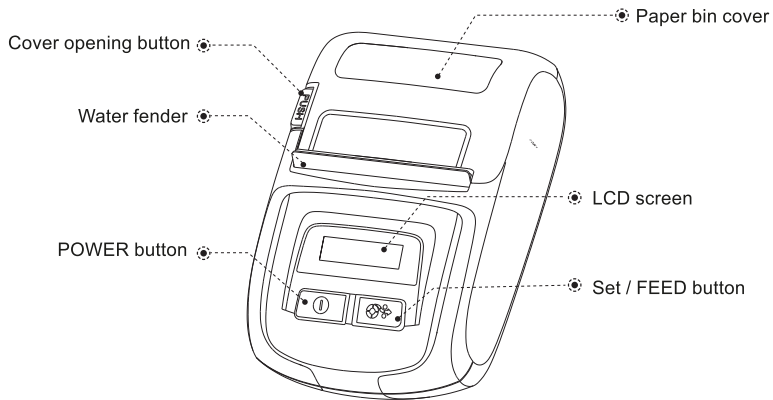



## □ Inside View

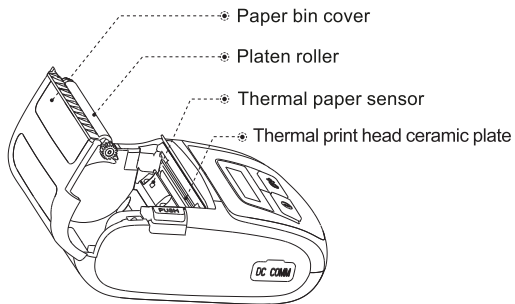

## □ Rear View

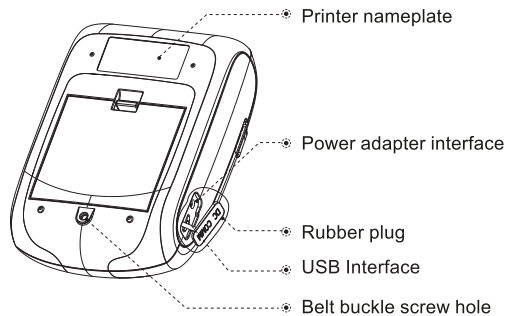

## III. Preparation Before Use

This chapter describes the steps to prepare the printer, including battery installation, battery charging, and printing paper loading.

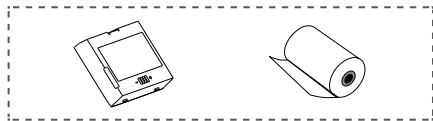

### 3.1 Battery Installation

The battery is installed in the printer before the product leaves factory.

- (1) Remove the protective film of battery contacts.
- (2) Install the battery as shown in the figure above.
- (3) Fasten the battery.

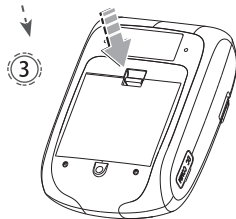
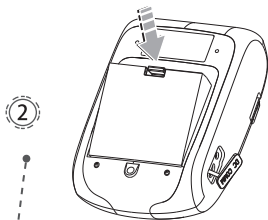
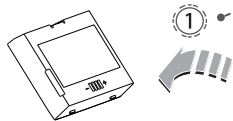

## 3.2 Battery Charging

### 1. Standby charging

Insert the power adapter plug into the power socket, and the DC plug into the printer charging port.

**Charging:** Battery indication icon  scroll display of battery indication slot.

**End of charging:** Battery indication icon shows  full battery.

#### **WARNING**

If you use a power adapter not provided or approved by us, the printer may be damaged.

#### **NOTE**

You can print while charging.  
The equipment supports fast charge function and can continue to print after short-time charging.

#### **ATTENTION**

Do not remove the battery while charging.

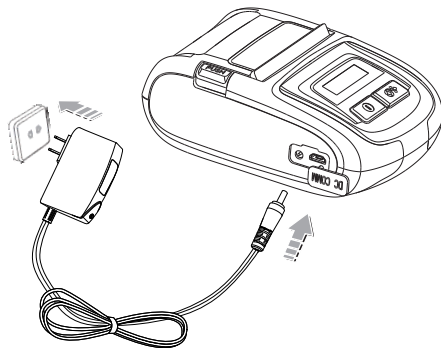

### 3.3 Installation Method 1 of Printing Paper Roll

Printing paper width of 58mm~56mm

(including thermal paper and label paper; the label paper width depends on the bottom paper width)

1. Remove the seal of the paper roll.
2. Press the cover opening button to open the paper bin.
3. Put the paper roll into the paper bin as shown in the figure.
4. Pull out a part of the paper along the exit and close the paper bin cover.

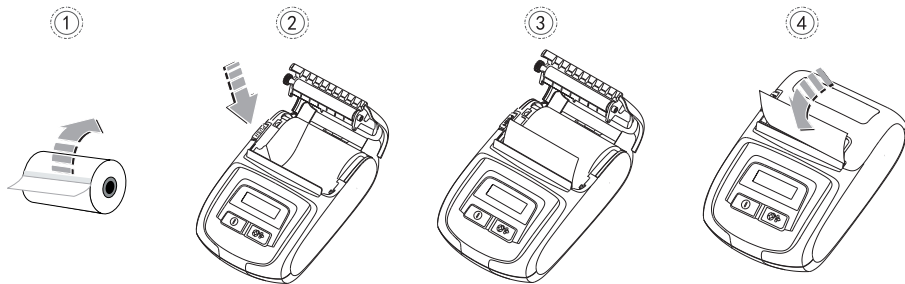

#### NOTE:

1. Paper specification used by the printer: Paper width: 58mm~20mm, paper roll diameter:  $\leq 40$ mm.
2. Pay attention to the direction of paper roll. If it is placed in the wrong direction, it will lead to blank printing.

### 3.4 Installation Method 2 of Printing Paper Roll

Printing paper width of 55mm~20mm  
(including thermal paper and label paper; the label paper width depends on the bottom paper width)

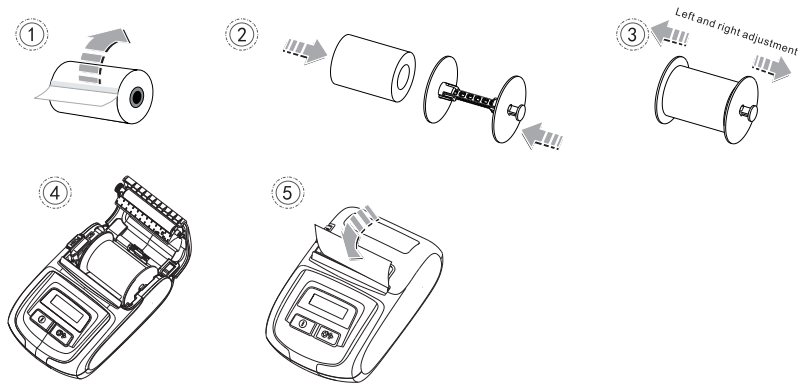

1. Remove the seal of the paper roll.
2. Load the paper roll into the paper width adjusting unit
3. Adjust the paper roll to the proper position.
4. Place the adjusted roll into the paper bin.
5. Pull out a part of the paper along the exit and close the paper bin cover.

## IV. Basic Functions



### 4.1 Power On

Press and hold the POWER button for 3 seconds to turn on the printer.

### 4.2 Power Off

During power-on state, press and hold the POWER button for 3 seconds to turn off the printer.

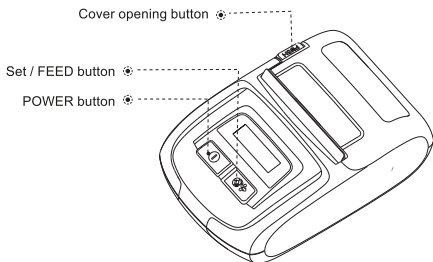

### 4.3 FEED

Under continuous feeding mode, touch the FEED button “”

Under feeding 6, black label mode or label mode, touch the FEED button “”

Feed the paper to the outside of black label or the space between labels

### 4.4 Auto Learning of Paper Types

Press and hold the FEED button “” to enter the setting screen, Press the SET button to select paper type: black label paper. Press and hold the FEED button to exit the setting screen, auto learning of paper types

### 4.5 Auto Sleep/Wake

#### Auto sleep

When the printer is turned on and has no button operation or data transmission within 10 seconds, it will automatically enter sleep mode. The screen display is shown in the figure.



#### Auto wake

When the printer is in sleep mode, it can be woke up by pressing the POWER button or when receiving data.

## V. Setting



ACE M1 has a multi-function LCD display, which can visually show the printer's connection status, power display, etc., and allow user to perform up to a dozen quick settings.

### Can be set in printer setting screen:

1. Select language
2. Set paper type (Label, Continuous, Black Label)
3. Set screensaver time

### 5.1 Enter Setting Screen

During power-on state (non-sleep mode), press and hold SET/FEED button to enter the option screen.

**Press SET/FEED button:** Go to the next option

**Press POWER button:** Change option parameters

**Press and hold SET/FEED button:** Confirm settings and exit

	print self-test page	Press and hold SET/FEED button to start printing self-test page
	1-3	Set wide range definition (coarse tuning)
	1-3	Set small range definition (fine tuning)
	0-4	Set print speed
	EngLish	Set language
	on	Set whether to turn on the buzzer
	continuous paper	Set according to the paper type used
	1-5H	Set auto shutdown
	Screensaver Time	Set screensaver time (four levels)

## 5.2 Self-test

The self-test page will list the model of printer, communication interface configuration, etc.

### Product information

---

Selftest  
Model:.....ACE M1  
Firmware Version:A43B1C0D1F0\_V1.22 2019-10-29  
Interface:.....USB  
Print Method:.....Direct Thermal  
Print Quality:.....2  
Print Density:.....2  
Print Speed:..... 4  
Font:.....24x24GB 18030  
Media Type:..... Receipt  
Instruction Set:..... TSC  
Dpi:..... 203

### Print size parameter

---

Size:.....0 mm , 0mm  
Reference:..... 0mm , 0mm  
Shift:..... 0mm  
Offset:..... 0mm

### POWER & DEGREE

---

[POWER & DEGREE]  
VOLTAGE:8.4 DEGREE:35

### Bluetooth Configure

---

[BlueTooth Configure]  
EDR NAME:.....ACE M1  
EDR PIN:.....0000  
BLE PIN:.....000000  
EDR ADD:.....DC-0D-30-7B-14-32  
BT VERS:..... 5.4.2,FSC-BT826

### WIFI Configure

---

[WIFI Configure]  
SSID:.....12345678  
Ethernet ID:.....41-38-30-31-35-37  
DHCP:.....Disable  
Ip :.....192.168.1.87  
Port:..... 9100  
NetMask:..... 255.255.255.0

 The display interface of Bluetooth version and WIFI version is slightly different, which shall be subject to the actual display.



## VI. Icon description



Printing status



This icon is displayed when the printer is printing or feeding paper.

Paper shortage state



When paper shortage occurs or the paper roll is not properly loaded

Cover opening state

Please close paper  
tank cover

When the r paper bin cover is not closed or not properly closed

Battery indication



When charging, the icon will scroll to indicate the charging status

Bluetooth indicator



The printer has Bluetooth function

WiFi indicator



The printer has WiFi function (✓: indicates successful WiFi connection)

## VII. Communication

---



### 7.1 USB Communication

ACE M1 provides Micro USB port, which is used to connect the printer to a PC as shown in the figure to charge the printer, set parameters, and transmit data, etc.

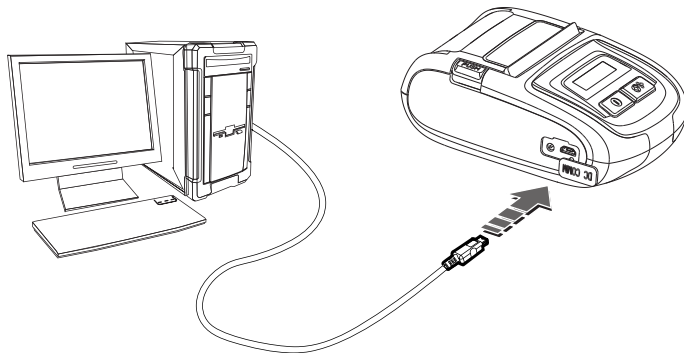

## 7.2 WiFi Communication

The mobile label printer can provide WiFi communication, and support STA mode and TPIK/AES encryption. Its effective communication distance is no more than 20m.



✎ WiFi information can be changed through the setting tool. For details, please refer to the "Instruction Manual for Setting Tool".

## 7.3 Bluetooth Communication

- 1.The mobile label printer can provide dual-mode Bluetooth 4.0 (SPP + BLE), which can communicate with Android system and IOS system terminals. Its effective communication distance is no more than 10m.
- 2.Support NFC fast Bluetooth pairing and connection  
(mobile phone with NFC function and APP will automatically connect with the printer after a contact)



✎ The default pairing password of Bluetooth is 0000 and the parameters can be set through the setting tool. For details, please refer to the "Instruction Manual for Setting Tool".

## VIII. Repair and Maintenance



### 8.1 Daily Maintenance of Printer

1. Cleaning of outside and paper bin: Wipe the surface of the printer and the inside of the paper bin gently with a wrung-out wet cloth. Make sure that the wet cloth is completely wrung out.
2. Cleaning of printer mechanism: The printer mechanism must be cleaned regularly, especially when the print quality declines. The cleaning method is as follows: Use absorbent cotton moistened with anhydrous alcohol to gently wipe the stains or the residue glue of label paper on the surface of the printer mechanism until it is clean.
3. If water is found inside the printer, Turn it off immediately, remove the battery, and dry the printer by airing.
4. If the printer will not be used for a long time, remove the battery and store it separately.

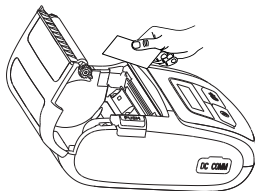

### 8.2 Use and Storage of Printing Paper

1. Please keep newly purchased printing paper in intact package and prevent it from direct sunlight and high temperature.
2. Please keep printed documents in a dark place at room temperature (about 20°C), so as to effectively extend the storage life of the documents.
3. If the documents need to be kept for a long time, please use long-lasting thermal printing paper.

## IX. Troubleshooting



Fault Phenomenon	Cause	Solution
Paper is fed but no data is printed.	Printing paper is loaded in the wrong direction.	Please load the printing paper in the other direction.
Blurry printing	The printer is not cleaned for a long time and the printer mechanism is contaminated by dirt.	Clean the printer mechanism.
	Poor color rendering of printing paper	Please set higher blackness or use paper with better color rendering
Printed documents are blurred in months or even weeks	Poor quality of printing paper	Please use long-lasting thermal printing paper
	Documents are kept at high ambient temperature	Please keep the documents at room temperature (about 20°C)

# X. Appendix



## 10.1 Printer Parameters

Printing Parameters	
Printing method	Thermal line printing
Print width	58mm~20mm
Paper roll diameter	≤40mm
Print speed	Max 80mm/s
Resolution	203dpi
Built-in font	GB18030 Simplified Chinese (standard)
Service life of printer mechanism	50km (label paper)
Command set	TSC / CPCL / ESC / POS
Print length	>200m
Print content	One-dimensional code: Code 39, 39C, I25, Code 93, ITF25, EAN128, Code 128, Codabar, EAN-8, EAN8+2, EAN8+5, EAN-13, EAN13+2, EAN13+5, UPC-A, UPCA+2, UPCA+5, UPC-E, UPCE+2, UPCE+5 MSIC, ITF14, EAN14, CODE11, POST QR code: QR CODE、PDF417 (Optional)

Printing Parameters	
Battery specification	7.4V 2000mAh rechargeable lithium ion battery
Charging time	3 hours
Wire communication	Standard USB2.0
Wireless communication	Dual-mode Bluetooth (Bluetooth 4.0 (SPP+BLE)/WIFI)
Working environment	Temperature: 0°C~40°C, Humidity: 20%~85%
Storage environment	Temperature: -20°C~70°C, Humidity: 5%~95%
Weight	0.3kg
Dimensions	125x82.2x48.3mm

## 10.2 Battery Recycling

This product uses a rechargeable lithium battery. To protect the environment, please do not dispose of used batteries at will. The supplier will provide you with battery recycling service.



**Rongta Technology (Xiamen) Group Co., Ltd.**

**ADD: No. 889 Xinmin Avenue, Tongan District, Xiamen, China**

**WEB: [www.rongtatech.com](http://www.rongtatech.com)**

**TEL: 0086-592-5666129      FAX: 0086-592-5659169**